

25mL Reagent Reservoir

Individually Wrapped CatNo's:

- 3054-1003 (Sterile, 50/case)
- 3054-2003 (Sterile, 100/case)

Bulk CatNo's:

- 3054-1002 (Sterile, 100/case, 10/bag)
- 3054-2002 (Sterile, 200/case, 20/bag)
- 4054-1002 (Non-Sterile, 100/case, 10/bag)

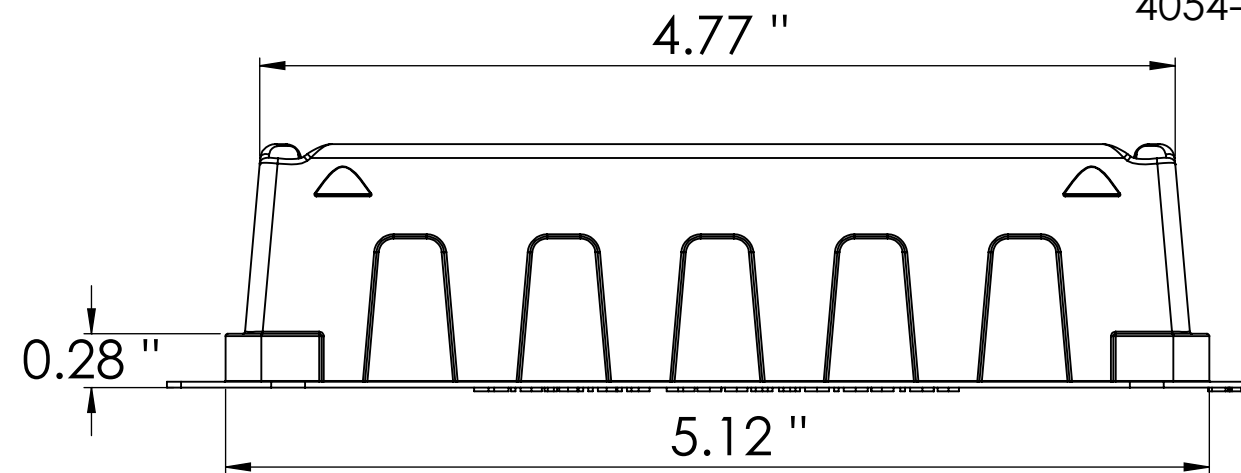
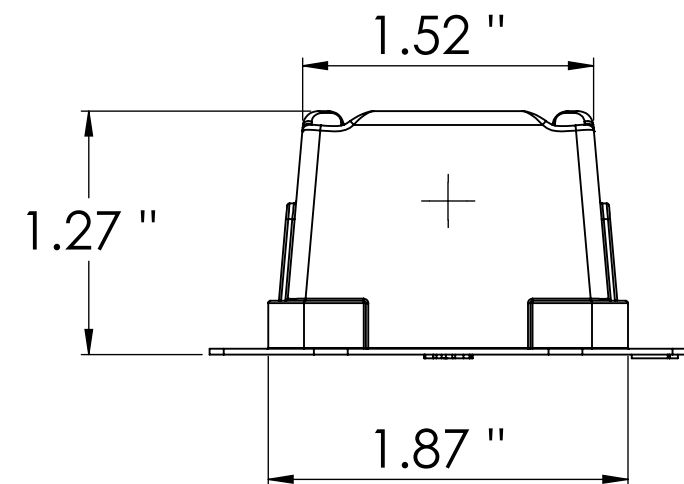

Material: Polystyrene

ALL DIMENSIONS FOR REFERENCE ONLY



VistaLab Technologies
2 Geneva Road
Brewster, NY 10509
Made in the USA

SCALE 1:1

Lit # L054-0028-001
Rev A